

aiwa

CD Stereo System

NSX-D70

U C

COMPACT
disc
DIGITAL AUDIO

OWNER'S RECORD

Record the model number and serial number of your set (found at the rear of your set) below. Refer to them when contacting your Aiwa dealer.

Model No. _____

Serial No. _____

For assistance and information
call toll free 1-800-BUY-AIWA
(United States and Puerto Rico)

OPERATING INSTRUCTIONS

E (English)

MANUAL DE INSTRUCCIONES

E (Español)

MODE D'EMPLOI

F (Français)

8C-NF6-903-11
020201BKH-U-M

WARNING

To reduce the risk of fire or electric shock, do not expose this appliance to rain or moisture.

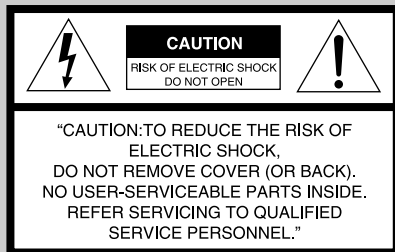

Explanation of Graphical Symbols:



The lightning flash with arrowhead symbol, within an equilateral triangle, is intended to alert the user to the presence of uninsulated "dangerous voltage" within the product's enclosure that may be of sufficient magnitude to constitute a risk of electric shock to persons.



The exclamation point within an equilateral triangle is intended to alert the user to the presence of important operating and maintenance (servicing) instructions in the literature accompanying the appliance.

IMPORTANT SAFETY INSTRUCTIONS

Read the Operating Instructions carefully and completely before operating the unit. Be sure to keep the Operating Instructions for future reference. All warnings and cautions in the Operating Instructions and on the unit should be strictly followed, as well as the safety suggestions below.

Warning

To prevent electric shock or injury, these safety instructions should be followed in the installation, use and servicing the unit.

Installation

Attachments - Do not use attachments not recommended by the unit manufacturer as they may result in the risk of fire, electric shock or injury to persons.

Water and Moisture - Do not use this unit near water - for example, near a bathtub, washbowl, kitchen sink, or laundry tub, in a wet basement, or near a swimming pool, and the like.

Heat - Do not use this unit near sources of heat, including heating vents, stoves, or other appliances that generate heat. It also should not be placed in temperatures less than 5°C (41°F) or greater than 35°C (95°F).

Mounting surface - Place the unit on a flat, even surface.

Accessories - Do not place this unit on an unstable cart, stand, tripod, bracket, or table. The unit may fall, causing serious injury to a child or an adult, and serious damage to the appliance. Use only with a cart, stand, tripod, bracket, or table recommended by the manufacturer, or sold with the unit. Any mounting of the appliance should follow the manufacturer's instructions, and should use a mounting accessory recommended by the manufacturer.

Portable cart - An appliance and cart combination should be moved with care. Quick stops, excessive force, and uneven surfaces may cause the appliance and cart combination to overturn.



Ventilation - The unit should be situated with adequate space around it so that proper heat ventilation is assured. Allow 10 cm clearance from the rear and the top of the unit, and 5 cm from the each side.

Slots and openings in the cabinet and the back or bottom are provided for ventilation, and to ensure reliable operation of the unit and to protect it from overheating, these openings must not be blocked or covered. The openings should never be blocked by placing the unit on a bed, sofa, rug or other similar surface. This unit should not be placed in a built-in installation such as a bookcase unless proper ventilation is provided.

Object and Liquid Entry - Never push objects of any kind into this unit through the cabinet slots as they may touch dangerous voltage points or short-circuit parts that could result in a fire or electric shock. Never spill liquid of any kind on the unit.

Electric Power

Power Sources - This unit should be operated only from the type of power source indicated on the marking label. If you are not sure of the type of power supply to your home, consult your appliance dealer or local power company. To operate unit on battery power, or other sources, refer to the operating instructions.

Grounding or Polarization - This unit is provided with a polarized alternating-current line plug (a plug having one blade wider than the other). This plug will fit into the power outlet only one way. This is a safety feature. If you are unable to insert the plug fully into the outlet, try reversing the plug. If the plug should still fail to fit, contact your electrician to replace your obsolete outlet. Do not defeat the safety purpose of the polarized plug.

Power-Cord Protection - Power-supply cords should be routed so that they are not likely to be walked on or pinched by items placed upon or against them, paying particular attention to cords at plugs, convenience receptacles, and the point where they exit from the product.

Overloading - Do not overload wall outlets, extension cords, integral convenience receptacles as this can result in a risk of fire or electric shock.

Outdoor Antenna

Power lines - An outside antenna system should not be located in the vicinity of overhead power lines or other electric light or power circuits, or where it can fall into such power lines or circuits. When installing an outside antenna system, extreme care should be taken to keep from touching such power lines or circuits as contact with them might be fatal.

Outdoor Antenna Grounding - If an outside antenna or cable system is connected to the unit, be sure the antenna or cable system is grounded so as to provide some protection against voltage surges and built-up static charges. Section 810 of the National Electrical Code, ANSI/NFPA No.70, provides information with regard to proper grounding of the mast and supporting structure, grounding of the lead-in wire to an antenna discharge unit, size of grounding conductors, location of antenna-discharge unit, connection to grounding electrodes, and requirements for the grounding electrode. See the figure.

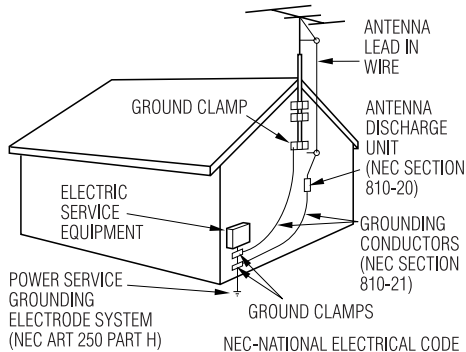

Lightning

For added protection for this unit receiver during a lightning storm, or when it is left unattended and unused for long periods of time, unplug it from the wall outlet and disconnect the antenna or cable system. This will prevent damage to the unit due to lightning and powerline surges.

Maintenance

Cleaning - Unplug this unit from the wall outlet before cleaning. Do not use liquid cleaners or aerosol cleaners. Use a damp cloth for cleaning.

Damage Requiring Service

Unplug this unit from the wall outlet and refer servicing to qualified service personnel under the following conditions:

- When the power cord or plug is damaged.
- If liquid has been spilled, or objects have fallen into the unit.
- If the unit has been exposed to rain or water.
- If the unit does not operate normally by following the operating instructions. Adjust only those controls that are covered by the operating instructions as improper adjustment of other controls may result in damage and will often require extensive work by a qualified technician to restore the unit to normal operation.
- If the unit has been dropped or the cabinet has been damaged.
- When the unit exhibits a distinct change in performance - this indicates a need for service.

Do not attempt to service this unit yourself as opening or removing covers may expose you to dangerous voltage or other hazards. Refer all servicing to qualified service personnel.

Replacement Parts - When replacement parts are required, be sure the service technician has used replacement parts specified by the manufacturer or having the same characteristics as the original part. Unauthorized substitutions may result in fire, electric shock or other hazards.

Safety Check - Upon the completion of any service or repairs to this unit, ask the service technician to perform safety checks to determine that the unit is in proper operating condition.

TABLE OF CONTENTS

IMPORTANT SAFETY INSTRUCTIONS	2
PREPARATIONS	4
PARTS AND CONTROLS	5
ADJUSTMENTS BEFORE OPERATIONS	8
CD OPERATIONS	10
RADIO OPERATIONS	12
TAPE OPERATIONS	14
SOUND ADJUSTMENTS	17
TIMER OPERATIONS	18
REFERENCE	20

System and accessories

NSX-D70

CX-ND70 CD stereo cassette receiver

SX-ND70 Front speakers

Remote control

FM antenna

AM antenna



PREPARATIONS

Connection

Plug in the AC power cord to the AC power outlet after all other connections are made.

1 Connect the front speakers.

Connect the right front speaker (marked "R" on the rear side) to the SPEAKERS R terminals and place it on the right side of the unit. Connect the left (marked "L" on the rear side) to the SPEAKERS L terminals and place it on the left side. The speaker cords with the white stripes go to the \oplus terminals.

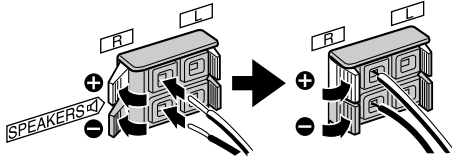

2 Connect the supplied antennas.

Strip off the insulation of the FM antenna with twisting the cord.

Connect the FM antenna to the FM 75 Ω terminal without the ∇ mark and the AM antenna to the AM LOOP terminals.

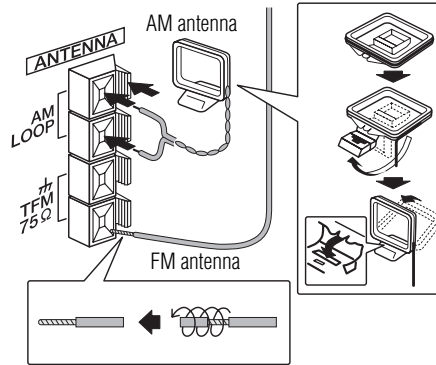

3 Connect the AC power cord to an AC outlet.

When the AC power cord is connected to an AC outlet for the first time, DEMO appears on the display.

To deactivate the DEMO, press DEMO/ECO.

- Do not short-circuit the \oplus and \ominus speaker cord leads.
- Do not leave objects generating magnetism or objects affected by magnetism near the speakers.

Remote control

Detach the battery compartment lid at the rear of the remote control and insert two R6 (size AA) batteries with correct polarity.

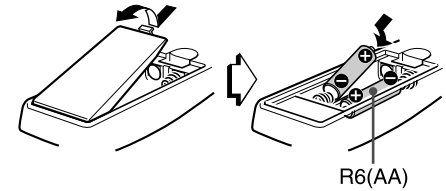

- Replace the batteries with new ones when the operational distance between the remote control and main unit becomes shorter.
- Remove the batteries if the unit is not going to be used for an extended period of time.
- The remote control may not operate if it is used under intense sunlight, etc., or if its line of sight is obstructed.

PARTS AND CONTROLS

Main unit: rear

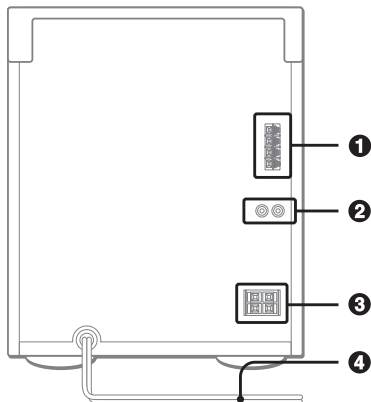

❶ AM LOOP, FM 75 Ω terminals

Plug in the supplied AM and FM antennas here.

❷ VIDEO/AUX jacks

Accepts analog sound signals from external equipment. Connect using an optional connecting cable with RCA phono plugs (red plug to R jack, white plug to L jack). Refer also to the operating instructions of your equipment. To switch function to external input, turn the Dial Function (see "ADJUSTMENTS BEFORE OPERATIONS") to select the VIDEO/AUX function.

Tip:

To change the displayed name for this function, select the VIDEO/AUX function, then hold down ENTER and press POWER on the unit. Repeat the procedure to select "AUX", "VIDEO" or "TV".

❸ SPEAKERS terminals

Connect the speaker cord of the supplied front speakers here.

❹ AC power cord

Dynamic Integrated Neo Amplifier

is a brand-new amplifier system where clear mid-to-high range frequency sound, as well as rich low frequency sound, can be reproduced and listeners can enjoy the close-to-original sound with less distortion at either high or low volume levels.

Main unit: front

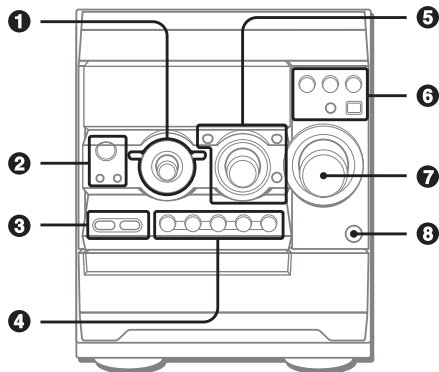

1 Dial Function

Selects a function (TAPE, TUNER, VIDEO/AUX or CD).

DECK 1/2

Selects DECK 1 or 2 in Tape function.

BAND

Selects a band in Tuner function.

2 POWER \odot STANDBY/ON

Switches the unit on and off (standby).

DEMO/ECO

When the unit is turned off: switches DEMO on and off.
When the unit is turned on: enters ECO or dimmer setting mode.

TIMER

Enters timer setting mode.

3 SYNC DUB

Starts dubbing a whole tape.

● REC/REC MUTE

Starts recording.

4 \parallel PAUSE/SET

CD and Tape: pauses playback.

Radio: stores the received station to preset.

■ STOP/CLEAR

CD and Tape: stops playback.

Radio: clears a station preset.

▶ PLAY/PRESET

CD and Tape: starts playback.

Radio: tunes into a preset station.

◀◀/I◀◀DOWN, ▶▶/▶▶UP TUNING

CD: skips to a previous or a succeeding track when pressed, searches a track in fast forward or fast reverse playback when held down.

Tape: fast forwards or rewinds the tape.

Radio: manually tunes down or up within the band.

5 MULTI JOG

CD: skips to a previous or a succeeding track.

Radio: selects a preset number.

Graphic Equalizer: selects a equalization curve or adjusts the level.

Clock and Timer: sets the time.

ECO and Dimmer: selects the mode.

MODE

Enters the setting mode of Graphic Equalizer or Spectrum analyzer display.

SOUND

Selects a frequency range of Graphic Equalizer to adjust the level.

ENTER

Determines the mode and the time (ECO, dimmer, clock and timer).

6 DISC DIRECT PLAY 1-3

Selects a CD tray.

DISC CHANGE

Rotates the CD trays.

▲ CD OPEN/CLOSE

Opens or closes the disc compartment.

7 VOLUME

Adjusts the volume.

8 PHONES jack

Plug in here an optional headphones set with a mini stereo plug ($\varnothing 3.5$ mm). Speaker output is canceled.

Remote control

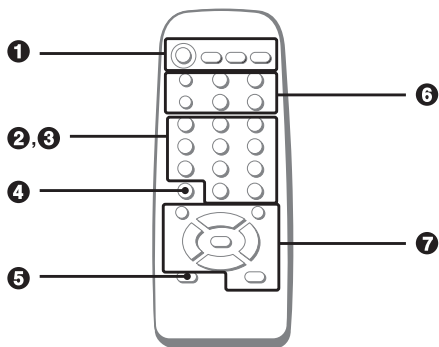

Buttons with the same or similar names with the main unit basically have the same function.

❶ POWER

GEQ

Enters Graphic Equalizer setting mode.

SOUND

ENTER

❷ 0-9, +10

CD: selects a CD track of the specified number.

Radio: tunes in to the station with the specified preset number.

❸ The numbered buttons take on these functions when pressed together with *SHIFT* held down:

PROGRAM

Enters programmed CD playback mode.

RANDOM/REPEAT

Enters random or repeat CD playback mode.

TUNER MODE

Switches between stereo or monaural FM reception.

DISPLAY

Selects a Spectrum analyzer display.

TIMER

SLEEP

Enters sleep-timer setting mode.

CLOCK

Enters clock adjustment mode.

CD EDIT/CHECK

Displays the remaining playback time of a CD when pressed during playback.

Enters AI Edit Recording or Programmed Edit Recording mode when pressed during stop.

❹ CD DIRECT

Select a CD tray with the numbered button (1-3).

❺ SHIFT

Hold down when pressing a numbered button to change its function to that printed above the number.

e.g.)

"Press **SHIFT+SLEEP** on the remote control" indicates "Hold down **SHIFT** and press '6' (**SLEEP**)", so that you can use 'Sleep timer' function.

❻ REC MODE

Starts recording with ●REC/REC MUTE.

●REC/REC MUTE

Starts recording with REC MODE.

PRESET (∧, ∨)

Performs the same functions as MULTI JOG on the unit.

VOLUME (+, -)

❼ DECK 1/2

BAND

||SET

▶/◀▶

The function is the same as that of ▶ on the unit.

◀◀/|◀◀, ▶▶/▶▶|

■CLEAR

FUNCTION

Switches the active function among TAPE, TUNER, VIDEO/AUX and CD.

ADJUSTMENTS BEFORE OPERATIONS

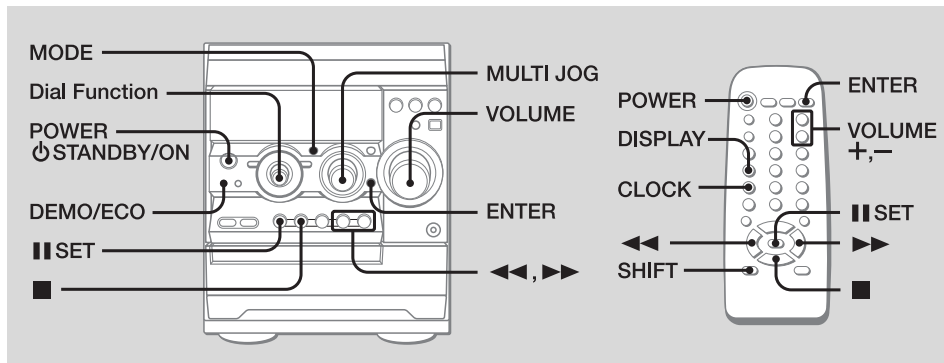

En

Power

Turning the unit on

Press POWER \odot STANDBY/ON (POWER on the remote control).

Turning the unit off

Press POWER \odot STANDBY/ON again.
The unit goes into standby.

Volume

Turn VOLUME (Press VOLUME +, - on the remote control).

Adjust from 0 (minimum) to 40 and MAX (maximum).

Tip:

Volume level setting is retained during power-off standby. If the unit is turned off with the volume set to 27 or more, it is automatically turned down to 26 the next time the unit is turned on.

Dial Function

Turn the Dial Function to select a function (TAPE, TUNER, VIDEO/AUX or CD).

The red light beside the selected function turns on.

DEMO

If the clock has not been set, a DEMO appears on the display when the unit is turned off.

To deactivate and activate the DEMO

Press DEMO/ECO when the unit is turned off.

Spectrum analyzer display

You can change the spectrum analyzer display.

Press MODE twice and then within 4 seconds turn MULTI JOG to select one of the three spectrum analyzer displays.

On the remote control, press SHIFT+DISPLAY repeatedly.

- NORMAL: Displays the fluctuation from low frequencies to high ones
- BASS: Displays the fluctuation of low frequencies only
- LEVEL: Displays the fluctuation of the average of all the frequencies.

ECO mode

Reduces power consumption with the following operations, etc.

ECO ON mode

- The unit blacks out when the unit is turned off. Only the red indicator lights up. (Only when the clock is set.)
- If dimmer mode is set to on, the unit illumination brightens (for 10 seconds) only when you operate the unit.

1 Press DEMO/ECO once when the unit is turned on, and then within 4 seconds press ENTER.

2 Turn MULTI JOG to select "ECO ON" and then press ENTER.
If there is no MULTI JOG or button operation within 4 seconds, the setting is canceled.

To cancel the ECO mode

Repeat the above and select "ECO OFF".

Dimmer

Adjusts the brightness of the display.

1 Press DEMO/ECO twice when the unit is turned on, and then within 4 seconds press ENTER.

2 Turn MULTI JOG to select one of the three dimmer modes or "DIM-OFF", and then press ENTER. "DIM-OFF" is the brightest and "DIMMER 3" is the dimmest.

If there is no MULTI JOG or button operation within 4 seconds, the setting is canceled.

To cancel the dimmer

Repeat the above and select "DIM-OFF".

Setting the clock

1 Press SHIFT+CLOCK on the remote control. When the unit is turned off, you can also press ■■SET.

2 Press ◀◀ or ▶▶ to set the time. Each press changes the time in 1-minute steps. Holding it down changes the time in 10-minute steps. If ◀◀ or ▶▶ is not pressed within 4 seconds, the setting is canceled.

- MULTI JOG is also available in place of ◀◀ or ▶▶.

3 Press ENTER or ■■SET. The time display stops flashing and the clock starts from 00 seconds.

To display the time

Press SHIFT+CLOCK on the remote control. The time will be displayed for 4 seconds, but it cannot be displayed during recording.

To switch to the 24-hour standard

Display the time and press ■ within 4 seconds. With each press, the clock alternates between the 12-hour standard and the 24-hour standard.

Tip:

In the 12-hour standard, "AM 12:00" indicates midnight and "PM 12:00" noon.

If the clock display flashes when the unit is turned off

There has been a power interruption. Re-set the clock.

CD OPERATIONS

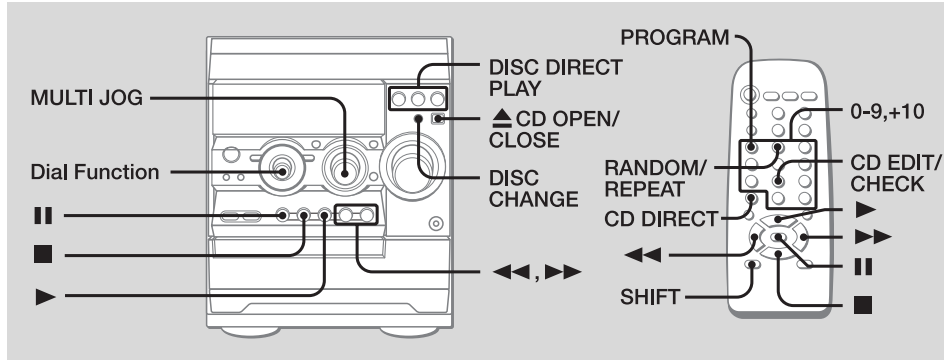

This unit plays back finalized CD-R/RW discs as well as audio CDs.

Playback

- 1 Turn the Dial Function to select the CD function and load disc(s).

Press **▲** CD OPEN/CLOSE to open the disc compartment and place one or two disc(s) with the labelled side up.

To place three discs, press DISC CHANGE so that the trays rotate, then place the third one. Lastly, close the compartment with **▲** CD OPEN/CLOSE.

- When loading an 8-cm (3-inch) disc, place it on the inner circle of the tray.
- When pressing **▲** CD OPEN/CLOSE or DISC CHANGE, the unit switches to the CD from any other functions.

- 2 To play all discs, press **▶**.

To play one desired disc, press DISC DIRECT PLAY 1-3.

Tray number being played back flashes.

To stop playback

Press **■**.

To pause playback

Press **II**. Press again to resume playback.

To skip to the beginning of the current/preceding succeeding track

Press **◀◀** or **▶▶** repeatedly or turn MULTI JOG.

To search (playback in fast forward or fast reverse)

Hold down **◀◀** or **▶▶**. Release at the desired point.

To select a disc and a track with the remote control

1 Press CD DIRECT, and then press the numbered button (1-3) within 3 seconds to select a disc.

2 Press the numbered buttons to select a track.

- To select track 25, press +10, +10 and 5.
- To select track 10, press +10 and 0.

To display the remaining playback time of the CD

Press SHIFT+CD EDIT/CHECK on the remote control. Press again to return to the elapsed time display.

- Remaining playback time cannot be displayed during random playback or programmed playback.

To replace disc(s) during playback without interruption

While one disc is being played back, press DISC CHANGE so that the compartment opens, replace disc(s) with other one(s), and press DISC CHANGE to close the compartment.

Random/Repeat playback

Random playback plays all the tracks on one desired disc or all the discs in random order. Repeat playback plays all the tracks repeatedly on one desired disc or all the discs.

- 1 Press SHIFT+RANDOM/REPEAT repeatedly on the remote control to select one of the following modes:

- Random playback: "RANDOM" lights up.
- Repeat playback: "↺" lights up.
- Random and repeat playback: "RANDOM" and "↺" lights up.

- 2 To play one desired disc, press DISC DIRECT PLAY 1-3.

To play all discs, press **▶**.

To cancel random/repeat playback

Press SHIFT+RANDOM/REPEAT repeatedly on the remote control so that both "RANDOM" and "↺" disappear on the display.

To repeat a selected set of tracks

Select the tracks with programmed playback, then press SHIFT+RANDOM/REPEAT on the remote control to select repeat playback.

- It is impossible to play a selected set of tracks in random order.

Programmed playback

Plays back up to 30 selected tracks in programmed order.

- 1** Press SHIFT+PROGRAM on the remote control during stop.
"PRGM" flashes on the display.
 - 2** Press CD DIRECT on the remote control and then press the numbered button (1-3) within 3 seconds to select a disc.
Go to the next step when the tray stops rotating.
 - 3** Press the numbered buttons on the remote control to program a track.
The selected track number lights up on the display.
 - To select the 25th track, press +10, +10 and 5.
 - To select the 10th track, press +10 and 0.
 - 4** Repeat step 2 and 3 to program other tracks.
 - 5** Press ►.
- During programmed playback, you cannot select a disc or a track with the numbered buttons. "CAN'T USE" is displayed when you try to select a track.
 - If the total playback time of the program exceeds 99:59 minutes, or if a track with a track number exceeding 30 is programmed, the playing time is displayed as "--:--".
 - You cannot program more than 30 tracks. "FULL" is displayed.

To check the program

Press ◀◀ or ▶▶ repeatedly during stop. The track number and program number are displayed in succession.

To clear the program

Press ■ during stop. "PRGM" disappears on the display.

To add tracks to the program

Repeat step 2 and 3 before starting playback. The tracks are added to the end of the program.

To change the programmed tracks

Clear the program and reselect the tracks in your desired order.

Notes on CDs

- Do not place more than one disc on one tray.
- Do not tilt the unit with discs loaded.
- The unit may not play a CD-R/RW disc recorded on personal computers or certain kinds of CD-R/RW recorders.
- Do not attach adhesive label, etc. to either side of a CD-R/RW disc, as doing so may cause malfunction.
- Do not load an unrecorded CD-R/RW disc. The disc may be damaged.
- Do not use irregular-shaped CDs.

RADIO OPERATIONS

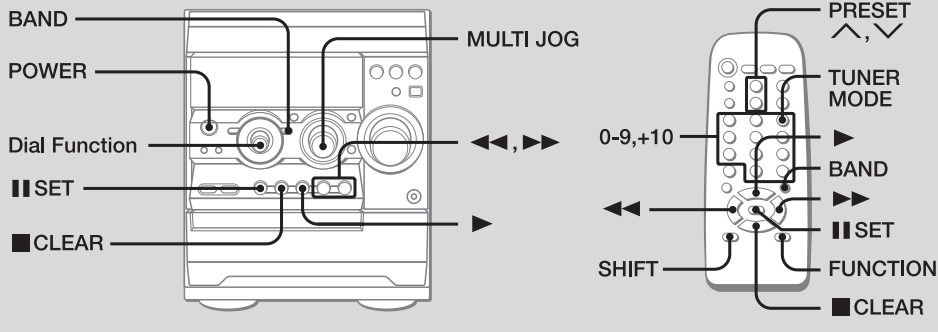

En

Manual tuning

- 1 Turn the Dial Function to select the TUNER function.
- 2 Press BAND to select a band (FM or AM).
- 3 Press ◀◀ or ▶▶ to tune in to a station. "TUNE" is displayed when a station is tuned in. "(((Ⓜ)))" lights up for FM stereo reception.

To search for a station automatically (Auto Search)

Hold down ◀◀ or ▶▶.

The unit searches for a station up or down the band and stops at reception.

To stop the search manually, press ◀◀ or ▶▶.

- Auto Search may not stop at stations with weak signals.

Preset tuning

Preset your favorite stations and tune them in directly by using preset numbers.

Presetting stations

- 1 Turn the Dial Function to select the TUNER function and press BAND to select a band.
 - 2 Press ◀◀ or ▶▶ to tune in to the desired station.
 - 3 Press SET to store the station. The preset number, beginning from "1", appears on the display.
 - 4 Repeat step 1 to 3 to preset other stations.
- You cannot store more than a total of 32 preset stations. "FULL" is displayed.

Tuning in to preset stations

On the unit

- 1 Turn the Dial Function to select the TUNER function and press BAND to select a band.
- 2 Press ▶ repeatedly or turn MULTI JOG. With each press, the station with the succeeding preset number is tuned in.

On the remote control

- 1 Press FUNCTION repeatedly to select the TUNER function and press BAND to select a band.
 - 2 Press the numbered buttons for the preset number of your desired station.
 - To select preset number 20, press +10, +10 and 0.
 - To select preset number 15, press +10 and 5.
- Pressing PRESET ^, v or ▶ repeatedly can also select the preset number.

To clear a preset station

- 1 Tune in to the station by preset tuning.
- 2 Press CLEAR, then press SET within 4 seconds. Preset numbers of preset stations in the band with higher numbers decrease by one.

Adjustments

Antennas

Keep antennas away from metallic objects, electrical equipment and cords.

FM antenna: Extend fully and position for the best reception. If receiving condition is poor, connect optional outdoor antenna to FM 75 Ω terminal. Be sure to connect the shield braid of the antenna to the ⚡ terminal.

AM antenna: Rotate to find best reception.

To switch to monaural FM reception

Press SHIFT+TUNER MODE on the remote control. With each press, "MONO" and "STEREO" are displayed alternately on the display.

Tip:

When FM stereo reception is poor, switching to monaural reduces noise.

To switch the AM tuning interval

Hold down BAND and press POWER on the unit. With each press, the AM tuning interval alternates between 9 kHz/step and 10 kHz/step.

Tip:

The default is 10 kHz/step. Change it only when using the unit in a 9 kHz/step area. Switching AM tuning interval clears all the preset stations.

TAPE OPERATIONS

En

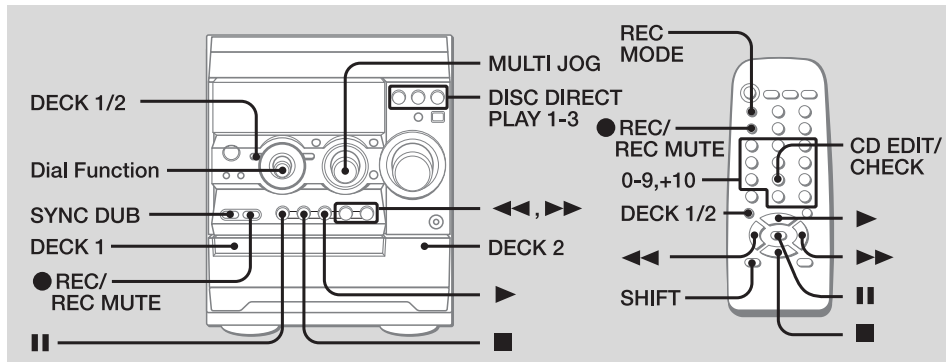

Playback

Use only type I (normal) tapes.

- 1 Turn the Dial Function to select the TAPE function.
- 2 Press ▲ PUSH EJECT/CLOSE on either side (DECK 1 and DECK 2) to open the outer cassette holder and insert the tape in the deck.
Insert with the exposed side down and playback side facing out from the unit. To close, push ▲ PUSH EJECT/CLOSE on the side where the tape is inserted.

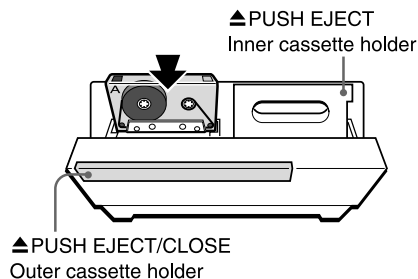

- 3 Press ►.

To open the inner cassette holder

The inner cassette holder opens or closes automatically when opening or closing the outer cassette holder. If the outer cassette holder is already open, press ▲ PUSH EJECT of the inner cassette holder to open it.

To open or close both decks (DECK 1 and DECK 2) simultaneously

Press or push ▲ PUSH EJECT/CLOSE on both sides of the outer cassette holder simultaneously.

To stop playback

Press ■.

To pause playback (DECK 2 only)

Press |||. Press again to resume.

To fast forward or rewind

Press ◀◀ or ▶▶.

To select a deck (DECK 1 or DECK 2)

Press DECK 1/2 in stop mode when tapes are loaded in both decks. The deck number ("T1" or "T2") is displayed.

To reset the tape counter

Press ■ in stop mode, and the tape counter on the display is reset to "0000". Opening and closing the cassette holder will also reset the tape counter.

To play continuously (DECK 1 to DECK 2)

Load tapes in both decks and start playback on DECK 1. Then, as soon as playback on DECK 1 finishes, playback on DECK 2 will start without interruption.

- The both decks play one side of the tapes.

To play back type II (High position) tapes

Turn MULTI JOG until "SOFT" is displayed while playing a type II tape.

The unit automatically sets the graphic equalizer to appropriate levels to provide the optimum playback sound for type II tape.

The "SOFT" function works even after the unit is turned off or the function is changed unless it is canceled.

To cancel it, cancel the graphic equalizer (see "SOUND ADJUSTMENT").

Notes on cassettes

- Use of 120-minute or longer tapes is not recommended since they are extremely thin and easily deformed or damaged.
- Take up any slack in the tape with a pencil or similar tool before use. Slack tape may jam in the mechanism.

Basic recording

Use only type I (normal) tapes. DECK 2 is the recording deck. Only one side of the tape can be recorded at a time.

- 1 Insert the recording tape in DECK 2.
Press ▲ PUSH EJECT/CLOSE to open the outer cassette holder, and insert with the exposed side down and the side to be recorded on facing out from the unit.
Wind up the tape to the desired point if needed.

2 Prepare the source.

To record CD(s), select the CD function and load disc(s).

To record a radio broadcast, tune in to the desired station.

To record a tape, insert the source tape in DECK 1 and select the TAPE function (DECK 1).

To record from connected external equipment, select the VIDEO/AUX function and prepare the equipment.

3 Press ● REC/REC MUTE to start recording.

When recording a CD or tape, playback starts automatically.

When recording input from connected equipment, manually start playback of the source.

On the remote control, press REC MODE and then press ● REC/REC MUTE within 3 seconds.

- You can also change the source by pressing REC MODE repeatedly before pressing ● REC/REC MUTE.

- Volume or tone adjustment does not affect recording.

- "CAN'T REC" is displayed if you attempt to record a tape with the tab broken off.

To stop recording

Press ■.

To pause recording (only for TUNER or VIDEO/AUX source)

Press ■■. Press again to resume.

To record a selected set of tracks from a CD

Program the desired tracks (see "Programmed playback") and then press ● REC/REC MUTE.

To record a 4-second blank space (only for TUNER or VIDEO/AUX source)

1 Press ● REC/REC MUTE during recording or in recording pause mode.

"REC" flashes on the display for 4 seconds (a blank space is made in the meantime) and then the unit enters recording pause mode.

To record less than a 4-second blank space, press ● REC/REC MUTE again while "REC" flashes.

To record more than a 4-second blank space, press ● REC/REC MUTE again after the unit enters recording pause mode. Each time the button is pressed, a 4-second blank space is added.

2 Press ■■ to resume recording.

To erase a tape

1 Insert the tape in DECK 2. Set the tape to the desired point if needed.

2 Press DECK1/2 to select "T2".

3 Press ● REC/REC MUTE.

Whole tape dubbing

1 Turn the Dial Function to select the TAPE function.

2 Insert the original tape in DECK 1 and the recording tape in DECK 2.

3 Press SYNC DUB.

The tapes are rewound to the beginning of the front side and recording starts.

- Dubbing cannot start from a point halfway in the tape.
- Only one side of the tape can be recorded at a time.

To stop dubbing

Press ■.

Edited CD recording

AI Edit Recording

When recording a whole CD, AI Edit Recording takes the length of your tape into account and rearranges the recording order of the tracks if necessary, so that no track is cut short at the end of the side. Prepare a tape long enough to record the CD.

1 Insert the recording tape in DECK 2.

2 Turn the Dial Function to select the CD function and load disc(s).

3 Press SHIFT+CD EDIT/CHECK once on the remote control.

"EDIT" is displayed and "AI C-00" appears on the display.

4 Press DISC DIRECT PLAY 1-3 to select a disc.

5 Press the numbered buttons on the remote control to enter the length of the recording tape.

10 to 99 minutes can be specified.

- For a 60-minute tape press 6 and 0.

In a few seconds, the unit determines the tracks to be recorded for each side.

The recording time left for side A appears on the display.

• ◀◀, ▶▶ or MULTI JOG can also be used to specify tape length.

6 Press ● REC/REC MUTE to start recording on side A.

On the remote control, press REC MODE and then press ● REC/REC MUTE within 3 seconds.

The tape is rewound to the beginning of side A and recording starts.

Go to the next step when recording on side A finishes.

7 Press SHIFT+CD EDIT/CHECK once on the remote control.

The recording time left for side B appears on the display.

8 Turn over the tape and press ● REC/REC MUTE to start recording on side B.

On the remote control, press REC MODE and then press ● REC/REC MUTE within 3 seconds.

- AI Edit Recording cannot be used with discs with more than 30 tracks. "TR OVER" is displayed.

- Recording cannot start from a point halfway in the tape.

Programmed Edit Recording

As you program the CD tracks to record, Programmed Edit Recording displays the remaining recording time for each side of the tape, so you can easily select a set of desired tracks within the length of your tape.

- 1 Insert the recording tape in DECK 2.
- 2 Turn the Dial Function to select the CD function and load disc(s).
- 3 Press SHIFT+CD EDIT/CHECK twice on the remote control.
"PRGM" and "EDIT" are displayed and "P C-00" appears on the display.
- 4 Press the numbered buttons on the remote control to enter the length of the recording tape. 10 to 99 minutes can be specified.
 - ◀◀, ▶▶ or MULTI JOG can also be used to specify tape length.
- 5 Press DISC DIRECT PLAY 1-3 to select a disc. Then, press the numbered buttons on the remote control to select the first track to be recorded on side A.
 - To select the 25th track, press +10, +10 and 5.
 - To select the 10th track, press +10 and 0.
- 6 Repeat step 5 to select the rest of the tracks for side A.
The remaining recording time of side A is displayed. You cannot select a track with a longer playing time.
- 7 Press SHIFT+CD EDIT/CHECK on the remote control to switch to side B and select the tracks for the side.
- 8 Press SHIFT+CD EDIT/CHECK on the remote control to switch back to side A.

- 9 Press ● REC/REC MUTE to start recording on side A.

On the remote control, press REC MODE and then press ● REC/REC MUTE within 3 seconds.

The tape is rewound to the beginning of side A and recording starts.

Go to the next step when recording on side A finishes.

- 10 Press SHIFT+CD EDIT/CHECK on the remote control to switch to side B.

- 11 Turn over the tape and press ● REC/REC MUTE to start recording on side B.

On the remote control, press REC MODE and then press ● REC/REC MUTE within 3 seconds.

- You cannot program more than 30 tracks. "FULL" is displayed.
- You cannot program a track with a track number larger than 30.
- Recording cannot start from a point halfway in the tape.

To stop recording

Press ■. Recording and CD playback stop simultaneously.

To check the program

1 Before recording, press SHIFT+CD EDIT/CHECK on the remote control to select side A or B.

2 Press ◀◀ or ▶▶ repeatedly. The track number and program number are displayed in succession.

To change the program of each side

Press SHIFT+CD EDIT/CHECK on the remote control to select side A or B, and press ■ to clear the program for the selected side. Then, select tracks again.

To clear the edit program

Press ■ twice so that "EDIT" disappears from the display.

To prevent accidental erasure

Break off the plastic tab of the cassette tape with a screwdriver or other pointed tool. To record on the tape again, cover the detection slot with adhesive tape.

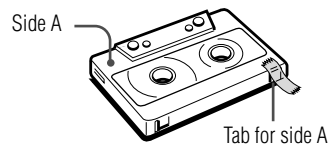

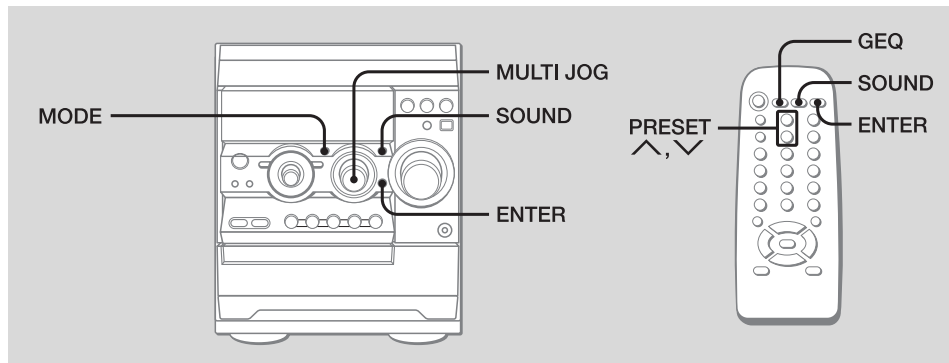

SOUND ADJUSTMENTS



Graphic equalizer

Selects a sound equalization curve to match the music type.

Press MODE once and then turn MULTI JOG within 4 seconds to select one of the four equalization curves.

On the remote control, press GEQ and then press PRESET  or  repeatedly within 4 seconds.

- ROCK: Powerful sound emphasizing treble and bass
- POP: More presence in the vocals and midrange
- JAZZ: Accented lower frequencies for jazz-type music.
- USER: A customized curve (see "Setting a curve manually")

To display the current GEQ mode

Press MODE (GEQ on the remote control) once. The mode will be displayed for 4 seconds.



To cancel equalization

Press MODE once and then turn MULTI JOG within 4 seconds to select "GEQ OFF".

On the remote control, press GEQ and then within 4 seconds press PRESET  or  repeatedly until "GEQ OFF" is displayed.

Setting a curve manually

The equalization curve can be customized to suit your preference.

- 1 Press SOUND repeatedly to select one of the three frequency ranges to adjust.
 - BASS: Low range frequencies
 - MID: Middle range frequencies
 - TRE: High range frequencies
- 2 Turn MULTI JOG (press PRESET  or  on the remote control) to adjust the level within 4 seconds.
- 3 Repeat Step 1 and 2 to adjust all the three ranges if necessary.

If you want to store your customized curve, proceed to the next step.

- 4 Hold down MODE (GEQ on the remote control) until "PRESET" flashes in the display and then press ENTER within 4 seconds.

The customized curve is stored in "USER"

- If you select one of the preset curves such as ROCK before performing STEP 1, you can customize a curve on it.
- Once one of the frequency ranges is adjusted, the GEQ indicator remains displayed until "GEQ OFF" is selected.

En

TIMER OPERATIONS

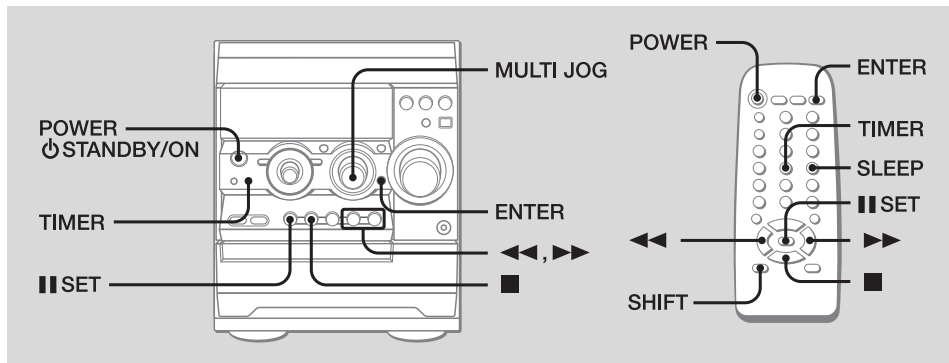

En

Sleep timer

Turns off the unit automatically after a specified time.

- 1 Press SHIFT+SLEEP on the remote control. "SLP" appears on the display.
- 2 Press ◀◀ or ▶▶ repeatedly to set the sleep timer duration. With each press, the timer duration changes in 5-minute steps between 5 to 240 minutes. If there is no button input for 4 seconds, the current setting is entered automatically. The unit turns off after the selected time.
 - MULTI JOG is also available in place of ◀◀ or ▶▶.

Tip:

The display is dimmed while the sleep timer is active.

To check the remaining time until the unit turns off

Press SHIFT+SLEEP on the remote control. The remaining time is displayed for 4 seconds.

To cancel the sleep timer

Press SHIFT+SLEEP twice on the remote control so that "SLP OFF" is displayed.

Timer playback

Turns on the unit at a specified time for the specified duration. Make sure the clock is set correctly.

- 1 Press TIMER (SHIFT+TIMER on the remote control). "Ⓢ" indicator lights up and "Ⓢ PLAY" appears on the display. Then, the timer-on time and the source name appear alternately on the display.
- 2 Press ◀◀ or ▶▶ to set the timer-on time, then press ENTER or II SET. If ◀◀ or ▶▶ is not pressed within 6 seconds, you will exit the timer setting mode and the previous setting, however, is entered.
- 3 Press ◀◀ or ▶▶ to select the source, then press ENTER or II SET.
- 4 Press ◀◀ or ▶▶ to set the timer-activated duration, then press ENTER or II SET. With each press, the timer-activated duration changes in 5-minute steps between 5 to 240 minutes.

5 Press ◀◀ or ▶▶ to adjust the volume level, then press ENTER or II SET. Adjust from 0 to 26.

6 Prepare the source.

To play CD(s), load disc(s).

To play the radio, select the band and tune in to the desired station.

To play a tape, insert the tape and select the deck.

To play external equipment connected to the VIDEO/AUX jacks, set an external timer for the equipment so that its playback begins at the same time.

7 Press POWER Ⓢ STANDBY/ON to turn the unit off.

At timer-on time, the unit turns on and plays the selected source. After the specified timer-activated duration, the unit turns off again.

Tip:

The display is dimmed while the timer playback is active.

- To stop timer setting in steps 2 to 5, press ■. Timer standby mode is also canceled.
- Timer playback will not begin unless the unit is turned off first.
- Connected equipment cannot be turned on or off by the built-in timer of this unit. Use an external timer.
- MULTI JOG is also available in place of ◀◀ or ▶▶.
- In step 3, FUNCTION or Dial Function is also available to select the source. In step 5, VOLUME +, - or VOLUME is also available to select the source.

To display the timer setting

Press TIMER.

The timer-on time, the source and the timer-activated duration are displayed for 6 seconds.

Tip:

Timer setting can be displayed even while the unit is turned off, and at that time if you press ENTER or **■** within 6 seconds after TIMER is pressed, you can enter the timer setting mode and change the setting.

To change the timer setting

Re-set the timer again.

To cancel the timer

Press TIMER repeatedly until "⊖ OFF" is displayed. "⊖" disappears from the display.

Tip:

Your timer setting is retained even if the timer is canceled. Next time the timer is activated, you can change your previous setting, or simply use the same setting again.

Timer recording

Timer recording is available only for TUNER and VIDEO/AUX (with an external timer) sources.

- 1** Press TIMER (SHIFT+TIMER on the remote control) repeatedly until "⊖REC" appears on the display.
- 2** Carry out step 2 to step 5 described in "Timer playback".
- 3** Prepare the source.
To record the radio, select the band and tune in to the desired station.
To record external equipment connected to the VIDEO/AUX jacks, set an external timer for the equipment so that its playback begins at the same time.
- 4** Insert the recording tape in DECK 2 and then turn the unit off.

Tip:

The display is dimmed while the timer recording is active.

REFERENCE

Care and maintenance

Occasional care and maintenance of the unit and the software are needed to optimize the performance of your unit.

To clean the cabinet

Use a soft and dry cloth. If the unit surfaces are extremely dirty, use a soft cloth lightly moistened with mild detergent solution. Do not use strong solvents such as alcohol, benzine or thinner.

To clean the tape heads

Dirty tape heads cause sound deterioration. After every 10 hours of use, clean the tape heads with a head cleaning cassette. Refer to the instructions of the cleaning cassette.

To demagnetize the tape heads

Use a demagnetizing cassette after every 20 to 30 hours of use. Refer to the instructions of the demagnetizing cassette.

Care of CDs

When a CD becomes dirty, wipe it from the centre out with a cleaning cloth. After playing a CD, store it in its case. Do not keep it in hot or humid places.

Care of tapes

Store tapes in their cases after use. Do not leave tapes near magnets, motors, television sets, or any source of magnetism. Do not expose tapes to direct sunlight, or leave them in a car parked in direct sunlight.

Troubleshooting

If your unit fails to perform properly, check the following guide and the relevant sections of the Operating Instructions.

There is no sound.

- Are the speakers and AC power cord connected properly?

The unit shut off suddenly.

- Possibly a short circuit in the speaker terminals. Disconnect the AC power cord from the AC power outlet and re-connect the speaker cords correctly.

The unit blacks out when the unit is turned off.

- Is ECO mode set to on?

Erroneous display.

- Reset the unit.

Poor radio reception.

- Check antenna connection. Adjust the antenna to find the best reception.
- Move unit and antenna away from other electric appliances and cords.

The tape does not run.

- Is the deck in pause?

Poor tape sound.

- Check for dirty heads. Clean them if needed.
- Use type I (normal) tapes.

Cannot record.

- Is the erasure prevention tab of the tape broken off? If so, cover the detection slot with adhesive tape.

The CD player works poorly.

- Is the disc correctly loaded?
- Is the disc dirty?
- Is the lens affected by condensation? If so, wait approximately one hour and try again.

Condensation

Moisture may form on the CD pickup lens when:

- The unit is moved from a cold spot to a warm spot
- The heating system has just been turned on
- The unit is used in a very humid room
- The unit is cooled by an air conditioner

When this unit has condensation inside, it may not function normally. Should this occur, leave the unit for a few hours, then try to operate again.

Resetting the unit

If an unusual condition occurs in the display window or the cassette deck, reset the unit as follows:

1 Press POWER to turn off the power.

If the power cannot be turned off, disconnect the AC power cord, then plug it in again.

2 Hold down **■** and press POWER.

Everything stored in memory after purchase is cleared.

Specifications

MAIN UNIT CX-ND70

TUNER

FM tuning range	87.5 MHz to 108 MHz
FM usable sensitivity (IHF)	13.2 dBf
FM antenna terminal	75 ohms (unbalanced)
AM tuning range	530 kHz to 1710 kHz (10 kHz step) 531 kHz to 1602 kHz (9 kHz step)

AM usable sensitivity	350 μ V/m
AM antenna	Loop antenna

AMPLIFIER

Power output	112 W + 112 W (40Hz -20 kHz, THD less than 1 %, 6 ohms) 140 W + 140 W (1 kHz, THD less than 10 %, 6 ohms)
--------------	--

Total harmonic distortion	0.08 % (56 W, 1 kHz, 6 ohms, DIN AUDIO)
---------------------------	---

Input	VIDEO/AUX: 700 mV
Outputs	SPEAKERS: 6 ohms or more PHONES: 32 ohms or more

CASSETTE DECK

Track format	4 tracks, 2 channels stereo
Frequency response	50 Hz – 15 kHz
Recording system	AC bias
Heads	DECK 1: playback x 1 DECK 2: recording/playback x 1, erase x 1

CD PLAYER

Laser	Semiconductor laser ($\lambda = 780$ nm)
D/A converter	1 bit dual
Signal-to-noise ratio	85 dB (1 kHz, 0 dB)
Harmonic distortion	0.05 % (1 kHz, 0 dB)

GENERAL

Power requirements	120 V AC, 60 Hz
Power consumption	120 W
Power consumption in standby mode	With ECO mode on: 0.6 W With ECO mode off: 25 W
Dimensions (W x H x D)	260 x 324 x 360 mm (10 1/4 x 12 7/8 x 14 1/4 in.)
Weight	8.5 kg (18 lbs 12 oz)

FRONT SPEAKERS SX-ND70

Speaker system	3 way, bass reflex (magnetic shielded)
Speaker units	Woofer: 160 mm (6 3/8 in.) cone Tweeter: 60 mm (2 3/8 in.) cone Super tweeter: 20 mm (13/16 in.) ceramic x 2
Impedance	6 ohms
Dimensions (W x H x D)	250 x 324 x 268 mm (9 7/8 x 12 7/8 x 10 5/8 in.)
Weight	4.5 kg (9 lbs 15 oz)

Specifications and external appearance are subject to change without notice.

COPYRIGHT

Check copyright laws relevant to recordings from discs, radio or tape for the country where the unit is to be used.



As an ENERGY STAR® Partner, AIWA has determined that this product meets the ENERGY STAR® guidelines for energy efficiency.

NOTE

This equipment has been tested and found to comply with the limits for a Class B digital device, pursuant to Part 15 of the FCC Rules. These limits are designed to provide reasonable protection against harmful interference in a residential installation.

This equipment generates, uses, and can radiate radio frequency energy and, if not installed and used in accordance with the instructions, may cause harmful interference to radio communications. However, there is no guarantee that interference will not occur in a particular installation. If this equipment does cause harmful interference to radio or television reception, which can be determined by turning the equipment off and on, the user is encouraged to try to correct the interference by one or more of the following measures:

- Reorient or relocate the receiving antenna.
- Increase the separation between the equipment and receiver.
- Connect the equipment into an outlet on circuit different from that to which the receiver is connected.
- Consult the dealer or an experienced radio/TV technician for help.

CAUTION

Modifications or adjustments to this product, which are not expressly approved by the manufacturer, may void the user's right or authority to operate this product.

REMARQUE

Cet appareil a été testé et jugé conforme aux normes des appareils numériques de Classe B, conformément au chapitre 15 du règlement FCC. Ces normes sont conçues pour assurer une protection raisonnable contre les interférences radioélectriques lorsque l'appareil est utilisé dans un environnement résidentiel.

Cet appareil génère, utilise et peut émettre des radiofréquences et, s'il n'est pas installé et utilisé conformément au mode d'emploi, il peut provoquer des interférences dans les communications radio. Il n'est cependant pas possible de garantir que des interférences ne se produiront pas dans une installation privée. Si cet appareil génère des interférences néfastes dans la réception des ondes radio ou télévisées, ce que l'on peut facilement contrôler en mettant l'appareil successivement sous et hors tension, l'utilisateur est invité à tenter de remédier aux interférences en appliquant l'une des mesures suivantes:

- Réorientez l'antenne de réception ou installez-la à un autre endroit.
- Eloignez davantage l'appareil du récepteur.
- Branchez l'appareil sur une prise secteur raccordée à un circuit d'alimentation différent de la prise sur laquelle le récepteur est branché.
- Consultez votre revendeur ou faites appel à un technicien radio/TV.

ATTENTION

Toute modification ou tout réglage de cet appareil non expressément approuvé par le fabricant peut invalider le droit de l'utilisateur à employer cet appareil.

CAUTION

TO PREVENT ELECTRIC SHOCK DO NOT USE THIS (POLARIZED) PLUG WITH AN EXTENSION CORD, RECEPTACLE OR OTHER OUTLET UNLESS THE BLADES CAN BE FULLY INSERTED TO PREVENT BLADE EXPOSURE.

This Class B digital apparatus complies with Canadian ICES-003.

(Only for C models)

ATTENTION

POUR PREVENIR LES CHOCS ELECTRIQUES NE PAS UTILISER CETTE FICHE POLARISEE AVEC UN PROLONGATEUR, UNE PRISE DE COURANT OU UNE AUTRE SORTIE DE COURANT, SAUF SI LES LAMES PEUVENT ETRE INSEREES A FOND SANS EN LAISSER AUCUNE PARTIE A DECOUVERT.

Cet appareil numérique de la classe B est conforme à la norme NMB-003 du Canada.

(Modèle C seulement)

For assistance and information

call toll free 1-800-BUY-AIWA

(United States and Puerto Rico)

AIWA CO.,LTD.



<http://www.aiwa.co.jp>

Printed in Malaysia